



IMMB-01-01-09-20-EN

Start up Guide

# Ultra-microbalances and Microbalances

---

## **Ultra-microbalances:**

- UYA 4Y PLUS
- UYA 4Y
- UYA 4Y.F PLUS
- UYA 4Y.F

## **Microbalances:**

- MYA 4Y PLUS
- MYA 4Y
- MYA 4Y.P PLUS
- MYA 4Y.P
- MYA 4Y.F PLUS
- MYA 4Y.F

To view a complete User Manual go to the website or scan QR code:



[radwag.com/en/manuals/3615](http://radwag.com/en/manuals/3615)

## 1. CONTENT

For models: UYA 4Y PLUS | MYA 4Y PLUS

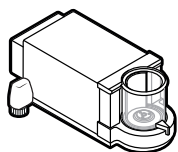

Microbalance  
x1

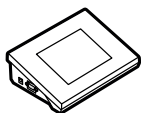

Terminal  
x1



Weighing pan  
x1



Anti-draft  
shield  
x1



Glass lid for the  
weighing chamber  
x1



Protective ring  
x1



Power adapter\*  
x1

For models: UYA 4Y | MYA 4Y

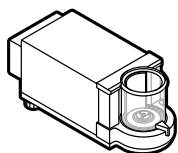

Microbalance  
x1

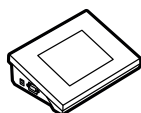

Terminal  
x1



Weighing pan  
x1



Anti-draft  
shield  
x1



Glass lid for the  
weighing chamber  
x1



Protective ring  
x1



Power adapter\*  
x1

*\*The plug type may vary by country.*

**For models: MYA 4Y.P PLUS**

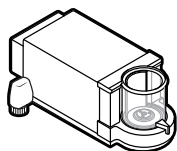

Microbalance  
x1

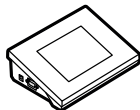

Terminal  
x1



Weighing pan  
x1



Anti-draft  
shield  
x1



Glass vessel  
x1



Evaporation ring  
x1



Glass lid with  
an opening  
x1



Additional  
glass lid  
x1

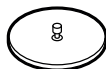

Glass lid for the  
weighing chamber  
x1



Protective ring  
x1



Power adapter\*  
x1

---

**For models: MYA 4Y.P**

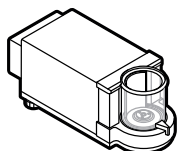

Microbalance  
x1

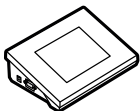

Terminal  
x1



Weighing pan  
x1



Anti-draft  
shield  
x1



Glass vessel  
x1



Evaporation ring  
x1



Glass lid with  
an opening  
x1



Additional  
glass lid  
x1

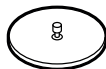

Glass lid for the  
weighing chamber  
x1



Protective ring  
x1



Power adapter\*  
x1

---

**For models: UYA 4Y.F PLUS | MYA 4Y.F PLUS**

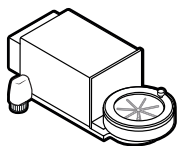

Microbalance  
x1

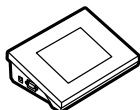

Terminal  
x1



Weighing pan  
for filters  
x1



Weighing pan  
x1



Centring ring  
x1



Power adapter\*  
x1

---

\*The plug type may vary by country.

For models: UYA 4Y.F | MYA 4Y.F

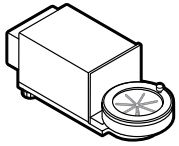

Microbalance  
x1

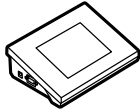

Terminal  
x1



Weighing pan  
for filters  
x1



Weighing pan  
x1



Centring ring  
x1



Power adapter\*  
x1

\*The plug type may vary by country.

## 2. UNPACKING

1

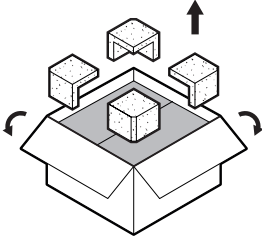

2

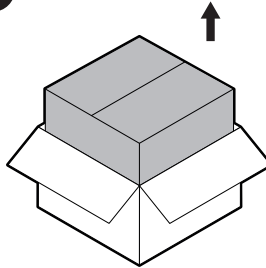

3

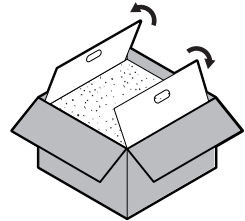

4

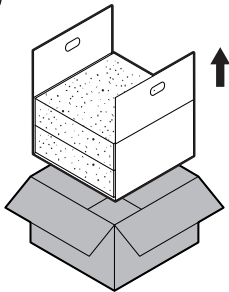

5

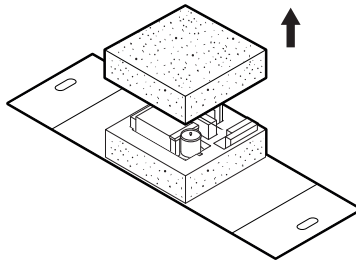

6

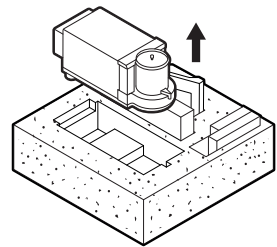

Keep the packaging should a warranty claim or service be required.

### 3. RECOMMENDATIONS AND WARNINGS

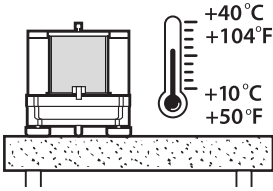

Operate the device in a room where the temperature ranges between 10–40 °C (50–104 °F) and where the relative humidity is below 80%. Temperature must change slowly and gradually.

Using the anti-vibration table is recommended in order to enable the most stable and repeatable measurement.

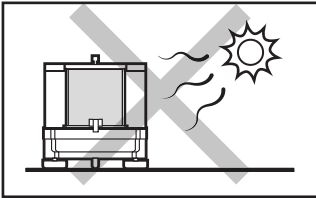

Place the balance away from heat sources. Avoid exposing the balance to the sunlight.

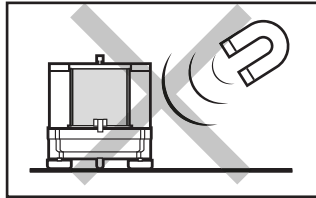

Avoid exposing the balance to a magnetic field. Do not weigh magnetic substances.

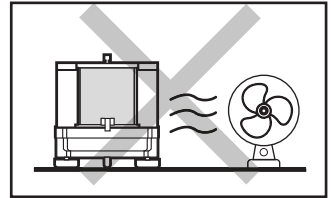

Avoid air drafts and air movements at the workstation.

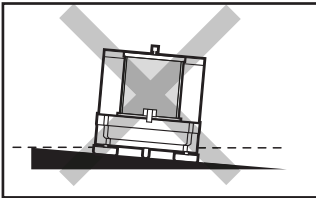

Make sure that the balance is placed on an even surface.

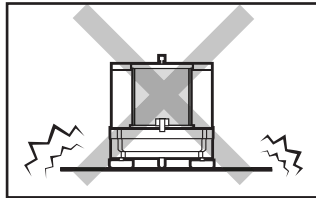

Do not place the balance on an unstable surface exposed to shocks and vibrations.

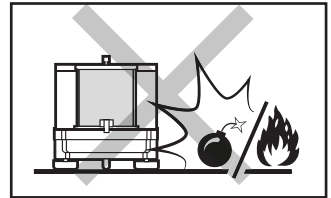

Do not place the balance in a hazardous area. Do not weigh explosive or flammable materials.

### 4. ACTIVITIES TO BE DONE PRIOR TO OPERATION

#### 4.1. Transport lock removal

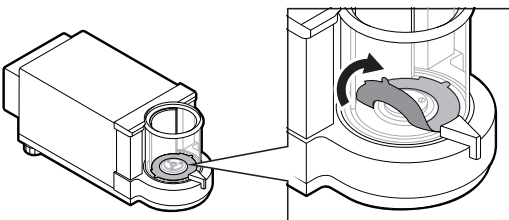

Prior to balance assembly remove the transport lock.

## 5. COMPONENTS ASSEMBLY

### 5.1. Weighing chamber components assembly

For models: UYA 4Y PLUS | MYA 4Y PLUS | UYA 4Y | MYA 4Y

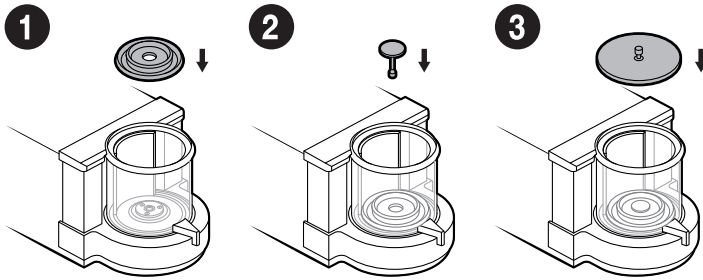

For models: MYA 4Y.P PLUS | MYA 4Y.P

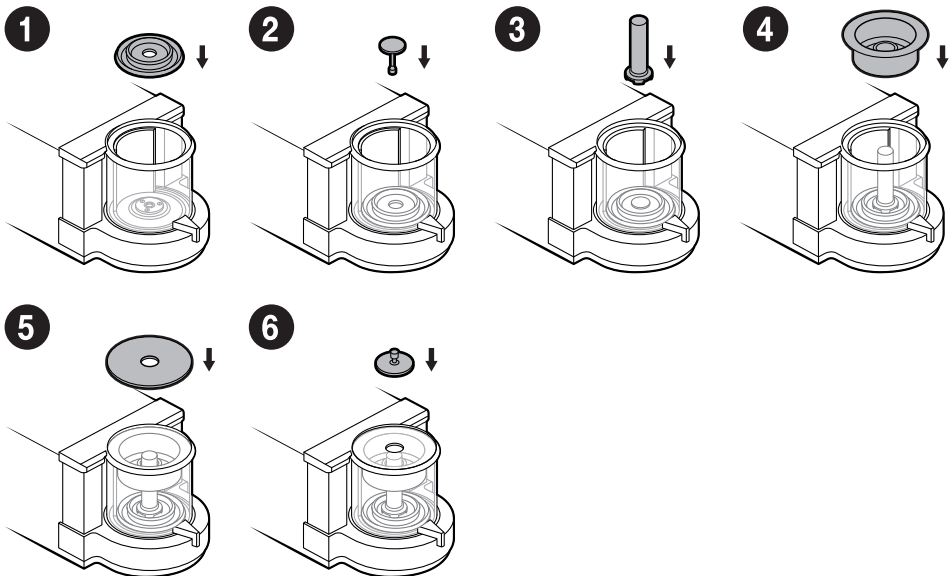

For models: UYA 4Y.F PLUS | MYA 4Y.F PLUS | UYA 4Y.F | MYA 4Y.F

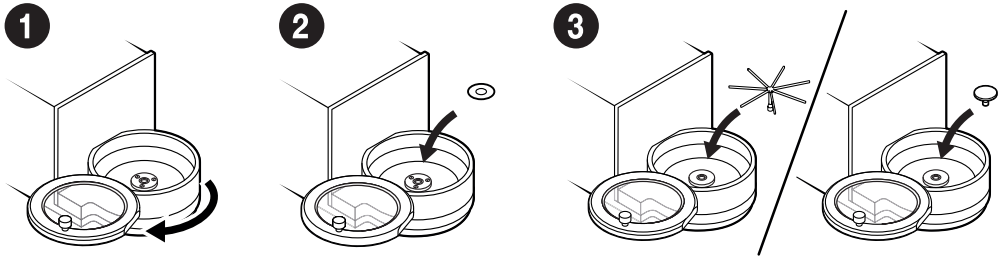

## 5.2. Connecting the terminal

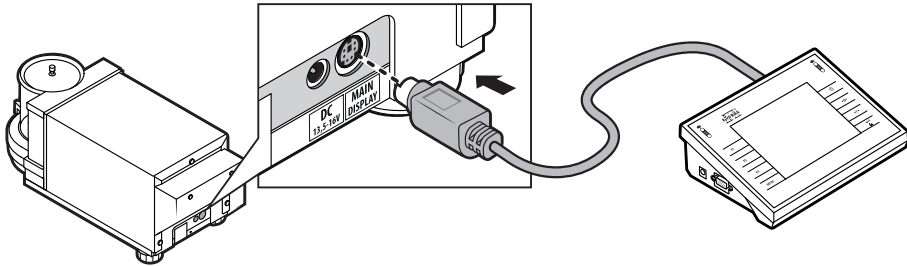

Connect the terminal to MAIN DISPLAY connector.

## 6. PREPARING FOR WORK

 Place the device at the workstation, wait until it reaches room temperature.

### 6.1. Temperature stabilization

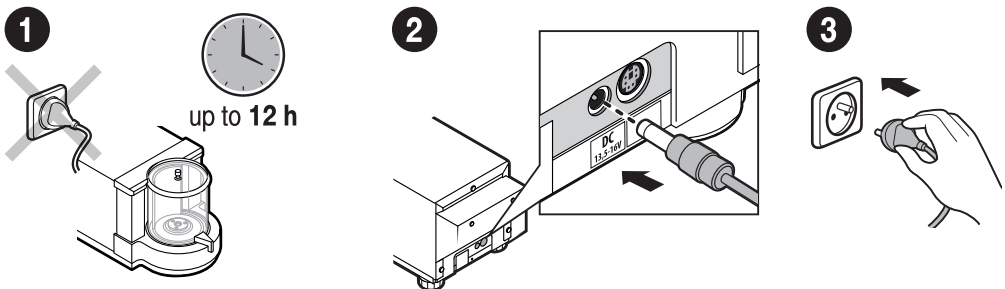

Prior to switching the device on let it reach room temperature (estimated stabilisation time: up to 12 hours).

Connect the power adapter to DC connector located at the back of the device.

Connect the power adapter to the mains.

## 6.2. Switching the balance on

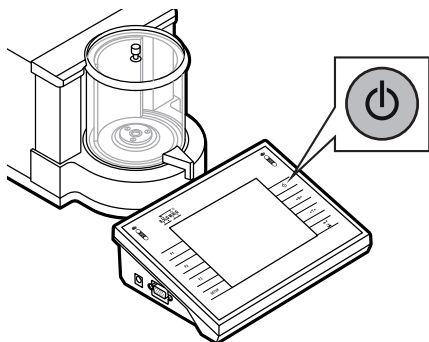

To switch the device on, press ON / OFF key.

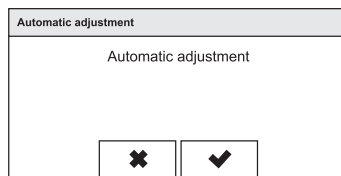

Confirm or cancel the start of the automatic adjustment process.

### 6.3.1. Balance levelling (for models with automatic levelling system only)



If your balance features an automatic levelling system, it will launch automatically upon turning the device on. To initiate the levelling manually, follow these steps:

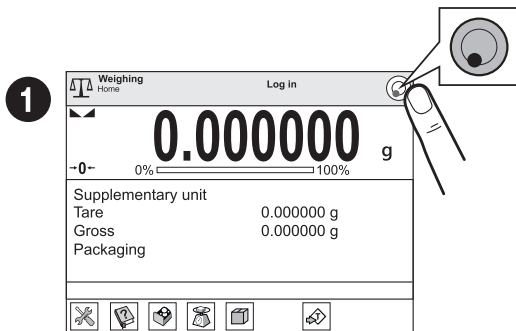

Press "Levelling" icon.

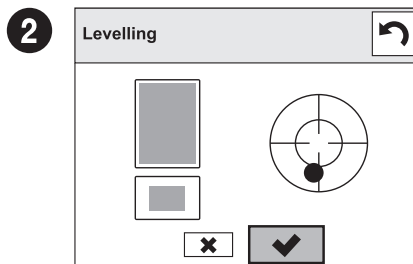

Confirm the automatic levelling process.

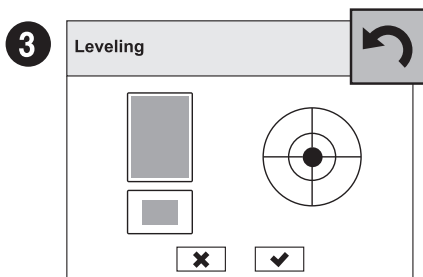

Balance has been levelled. To close the levelling window press  button.



## 6.3.2. Balance levelling (for models with semi-automatic levelling only)

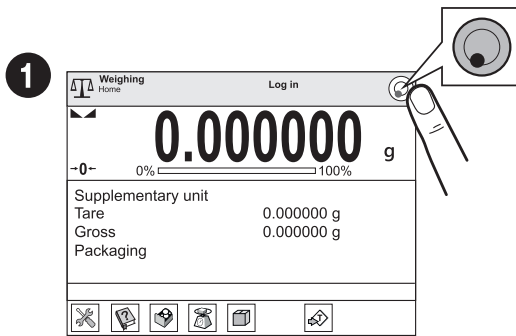

Press "Levelling" icon.

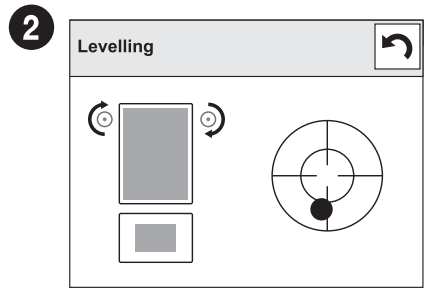

Check the balance level state. The arrows shows how to move the balance feet to level the balance.

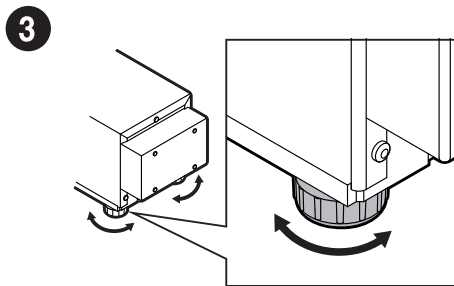

To level the balance turn its feet, keep turning the feet until the level indicator takes central position.

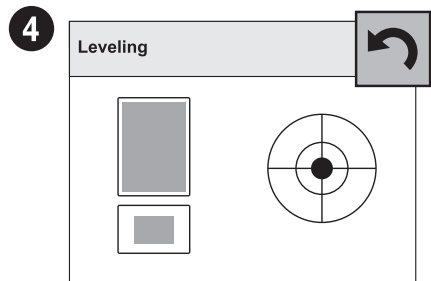

Balance has been levelled. To close the levelling window press  button.



Your balance is ready to use!

# 7. PANEL AND SCREEN

## 7.1. Panel keys

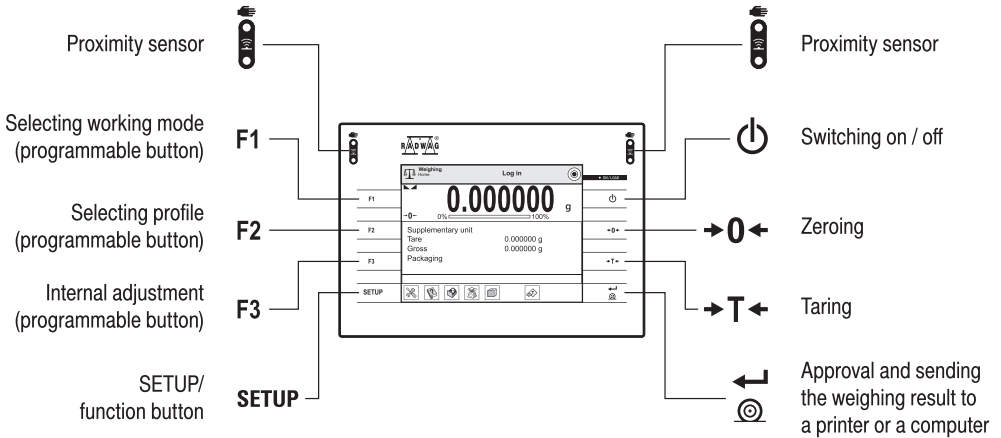

## 7.2. Home screen

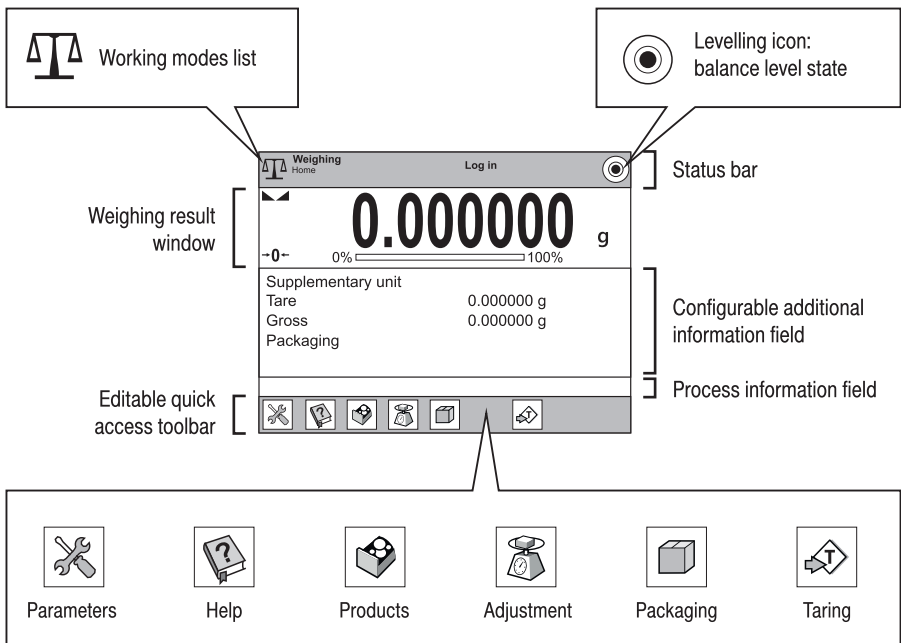

## 8. BASIC OPERATIONS

### 8.1. Adjustment

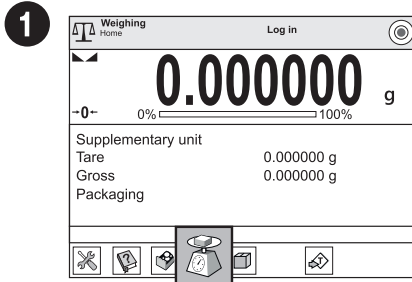

Press "Adjustment" button and wait for completion of the adjustment process.

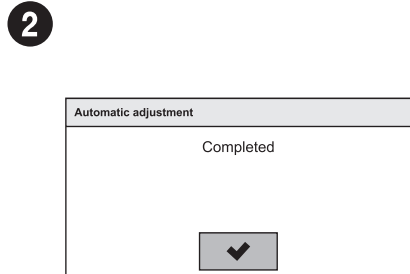

Adjustment completed. Press  button for confirmation.

### 8.2. Zeroing

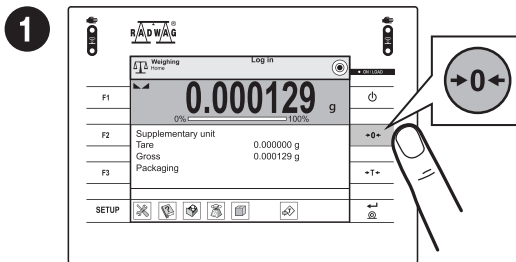

Make sure that the weighing pan is empty and press "Zero" button.

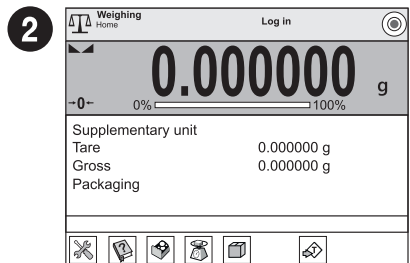

The balance has been zeroed.

### 8.3. Taring

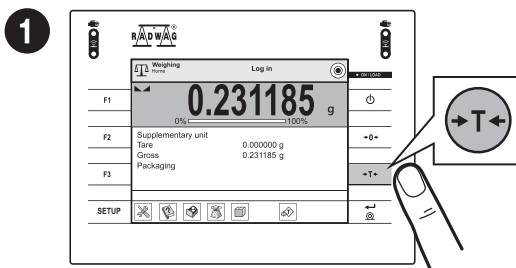

With loaded weighing pan: upon stabilisation of the weighing result, press "Tare" button.

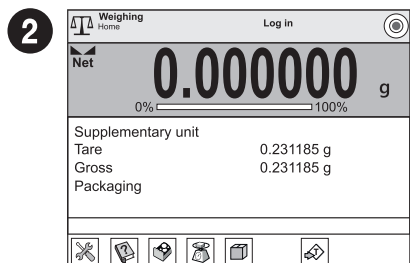

Balance has been tared.

## 8.4. Working modes / units selection

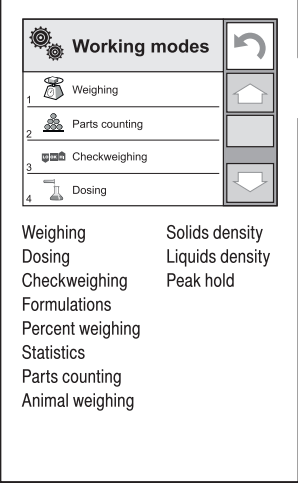

**Working modes**

- 1 Weighing
- 2 Parts counting
- 3 Checkweighing
- 4 Dosing

Weighing      Solids density  
 Dosing        Liquids density  
 Checkweighing    Peak hold  
 Formulations  
 Percent weighing  
 Statistics  
 Parts counting  
 Animal weighing

Press the icon of the current working mode, to display the list of working modes.

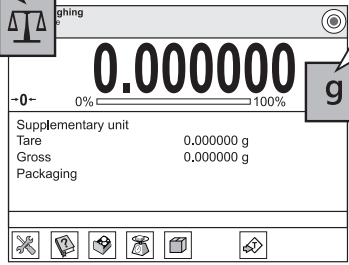

Press the current weight unit icon to display list of available units.

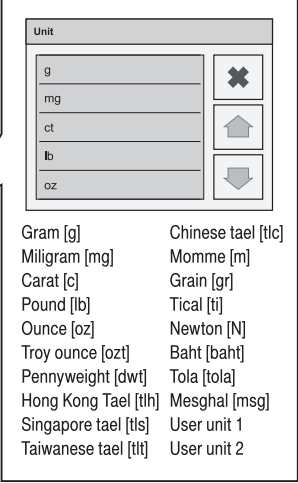

**Unit**

- g
- mg
- ct
- lb
- oz

Gram [g]            Chinese tael [tlc]  
 Miligram [mg]      Momme [m]  
 Carat [c]            Grain [gr]  
 Pound [lb]          Tical [ti]  
 Ounce [oz]          Newton [N]  
 Troy ounce [ozt]    Baht [baht]  
 Pennyweight [dwt]    Tola [tola]  
 Hong Kong Tael [tth]    Mesghal [msg]  
 Singapore tael [tls]    User unit 1  
 Taiwanese tael [tit]    User unit 2

## 8.5. Working modes settings

**1**

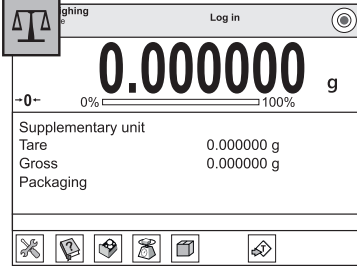

Press the icon of the current working mode, to display the list of available working modes.

**2**

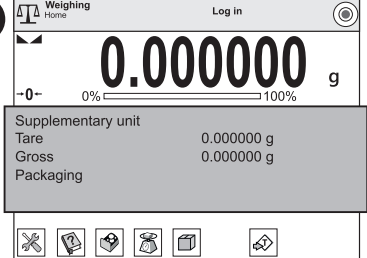

Press information field to access current working mode options.

**3**

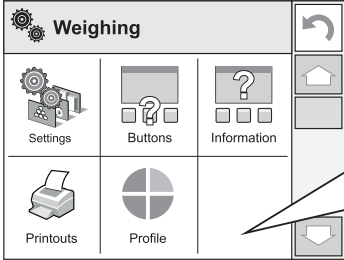

- Settings:** additional options
- Buttons:** quick access buttons configuration
- Information:** setting data that is to be displayed in the workspace
- Printouts:** setting printout type and conten
- Profile:** setting profile that is to be used during operation

Press selected button to view the list of available options.

## 9. SETTINGS



Some settings are accessible for Administrator exclusively.  
Prior to balance parameters setup, log in as the Administrator.

### 9.1. Administrator's logging in

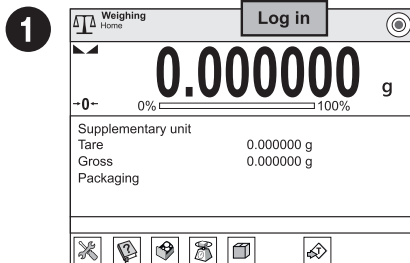

To enter "Users" menu press "Log in" button.

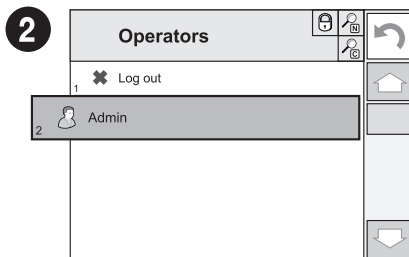

Users list is displayed, select "Admin" option.

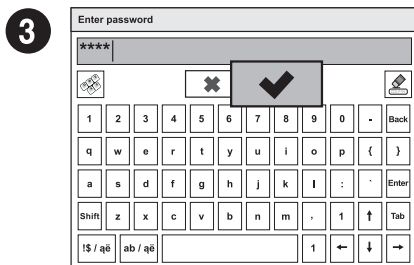

Enter "1111" password and press  button to confirm.

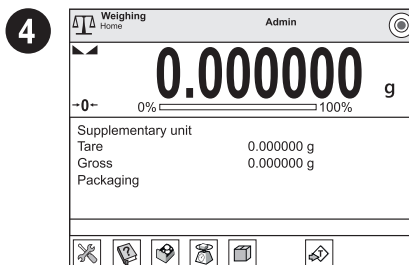

You have logged in as the Administrator.

### 9.2. User settings



Prior to users settings, log in as Administrator (point 9.1.).

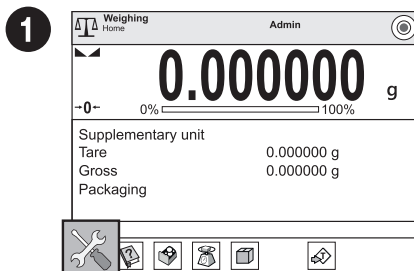

Press "Parameters" button.

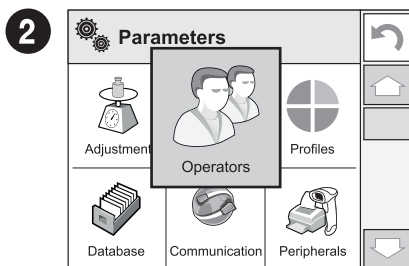

Press "Operators" button.

3

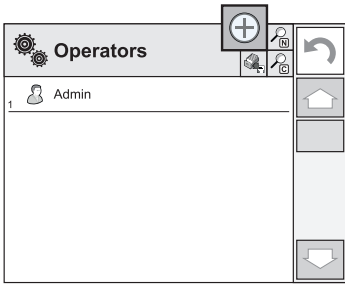

Press "Add" button.

4

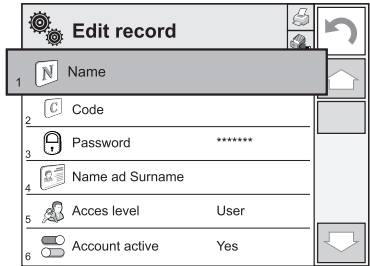

Select "Name" parameter.

5

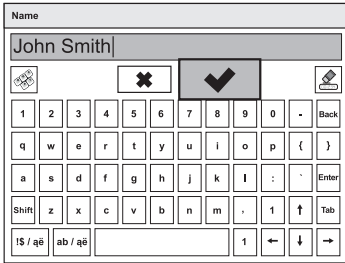

Enter user name and press  button to confirm.

6

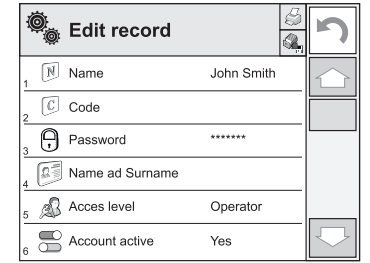

User name has been entered.

7

Following the above procedure, set remaining parameters:

**Code:**

Enter user ID

**Password:**

Enter user password

**First and last name:**

Enter user's first and last name

**Access levels:**

Set respective access level  
(user, advanced, admin)

**Account status:**

(active or inactive)

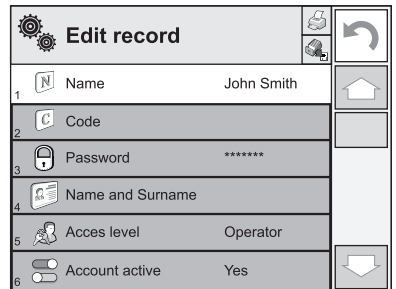

## 9.3. Proximity sensors setup



Prior to proximity sensors setup, log in as Administrator (point 9.1.).

You can assign the proximity sensors with different functions for each working mode (the sensors will trigger different operation for each working mode). See the below procedure of sensors setup for the “Weighing” mode.

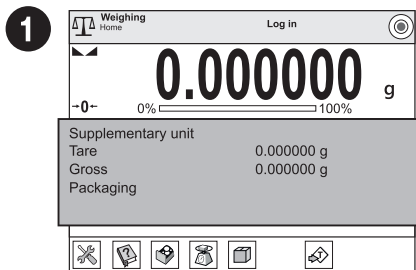

Press information field to access current working mode options.

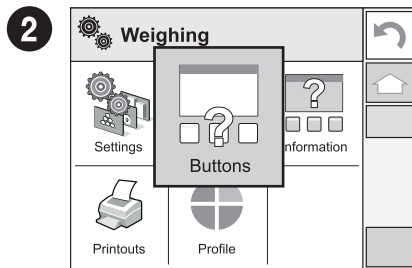

Press “Buttons” button.

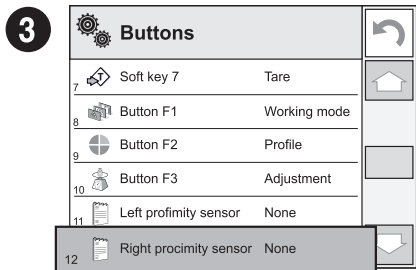

Select the appropriate sensor (right or left).

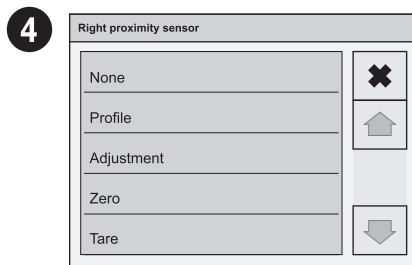

Select function that is to be assigned to the chosen sensor.



Following the above procedure you can configure sensors for other working modes.

# 10. PERIPHERAL DEVICES CONNECTORS

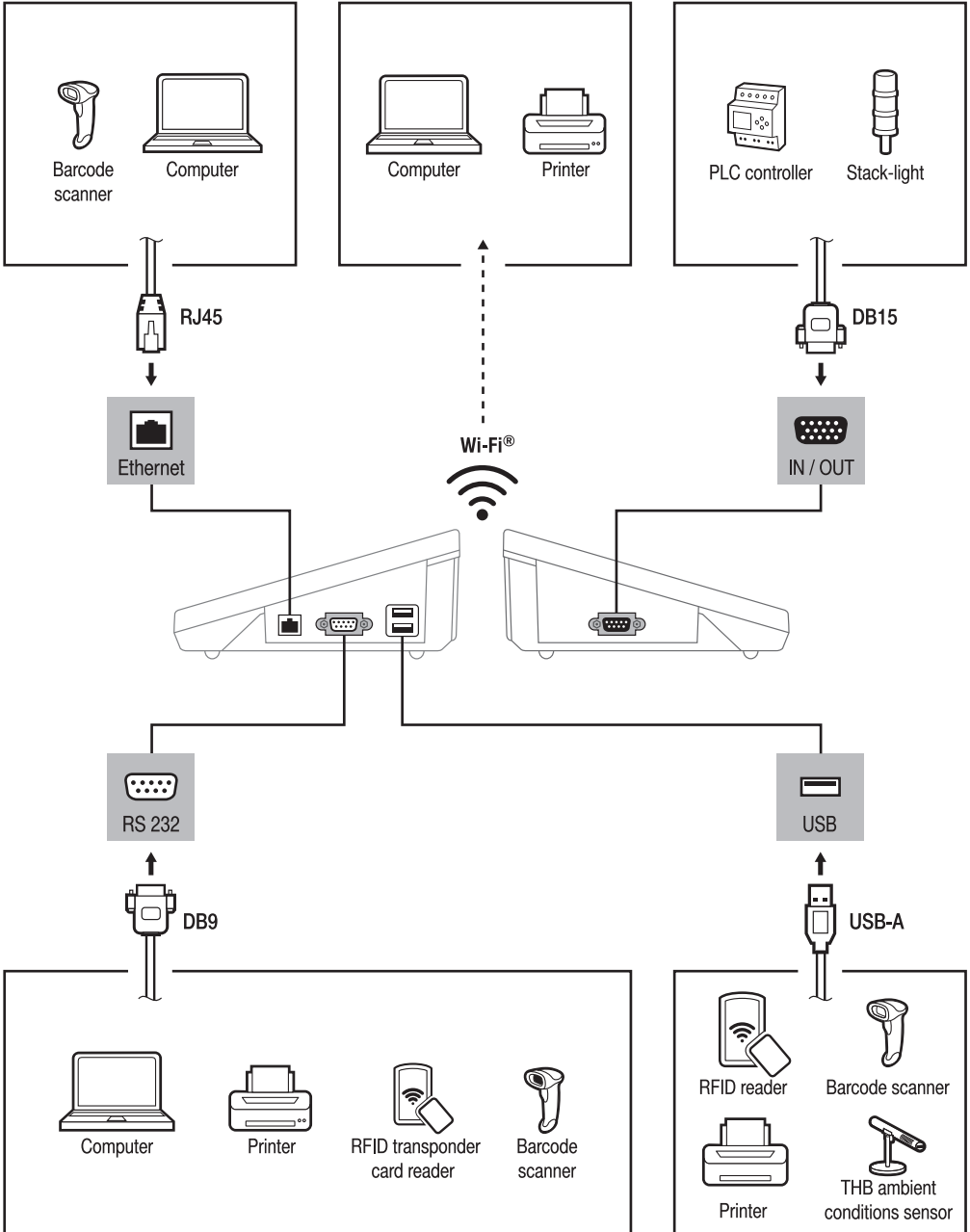



## 11. DEVICE CLEANING

### 11.1. Guidelines and precautions

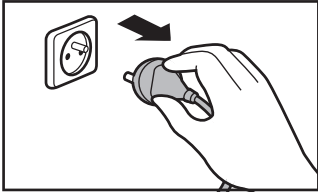

Prior to cleaning it is necessary to disconnect the device from the mains! Remove the plug from the outlet, disconnect all cables.

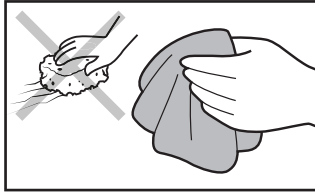

Use soft cloth made of either natural or synthetic fiber exclusively. Avoid using cloth made of stiff/hard fabric, this could cause scratches on the surface!

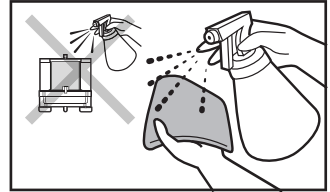

Apply the cleanser onto the cloth. Mind not to apply the cleanser directly onto the device!



Do not use aggressive cleaning agents (e.g. solvents, chlorine preparations, corrosive chemicals, bleach).



Neither use substances of sharp structure nor intended for scrubbing.



Make sure that neither dust nor liquid gets inside the weighing system (device inside).

### 11.2. Cleaning instructions



Shall it be necessary to disassemble the weighing chamber, follow the description provided in section 11.3.

- **GLASS PANES AND COMPONENTS** can be cleaned using window cleaner.
- **WEIGHING PANS AND STAINLESS STEEL OR ALUMINIUM COMPONENTS** can be cleaned using a cloth slightly soaked in a solution of water and gentle cleanser (e.g. soap or dishwashing liquid).
- **OPERATION PANEL AND HOUSING** can be cleaned using a cloth slightly soaked in a solution of water and gentle cleanser (e.g. soap or dishwashing liquid).
- Dry sample leftovers can be removed using either brush or handheld vacuum cleaner.
- Clean components can be dried using soft cloth or dust-free paper towel, with this the remaining moist will be absorbed.
- **Install all the components providing they are completely dry.**

## 11.3. Weighing chamber elements disassembly



Prior disassembling weighing chamber elements make sure the microbalance is turned off and unplugged from the mains. When disassembling the elements, use tweezers that come standard with the instrument.

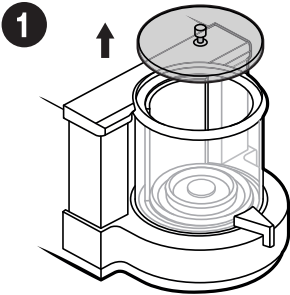

Lift the lid of microbalance weighing chamber.

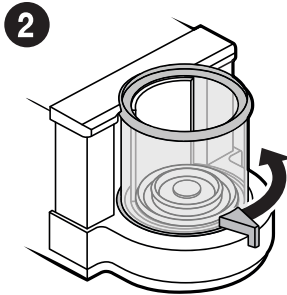

Open the weighing chamber by twisting the handle.

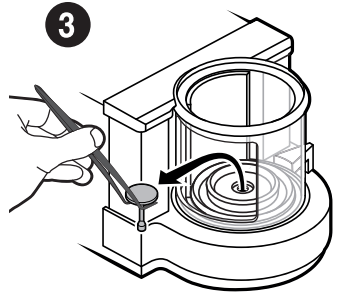

Using the tweezers, carefully remove the weighing pan from the weighing chamber.

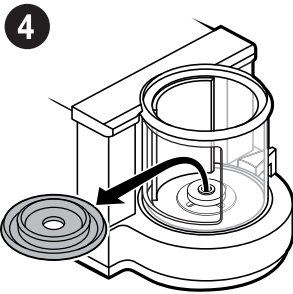

Remove the draft shield from the weighing chamber.

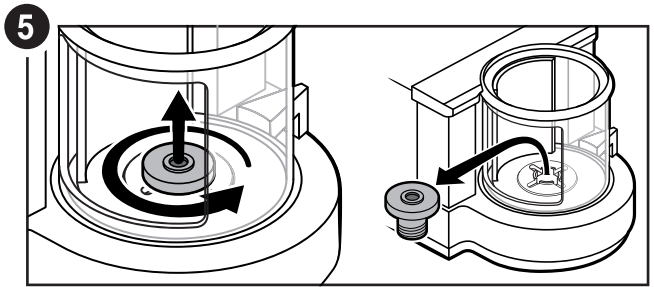

Unscrew the draft shield's sleeve counterclockwise and remove it from the weighing chamber.

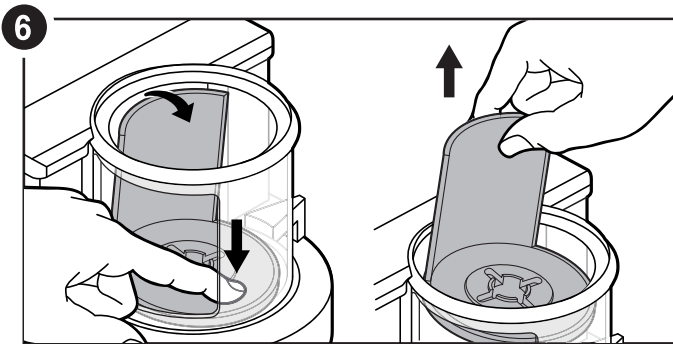

Use your finger to press the base of the ring assembly in order to tilt the top edge. Grab the top edge and remove the ring assembly through the upper hole of the weighing chamber.

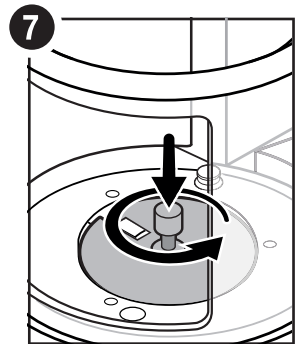

Install and tighten the protective ring using the handle.

8

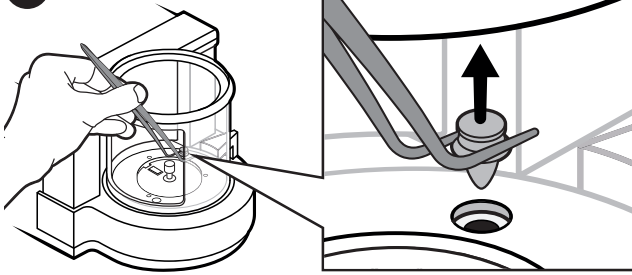

Remove the plastic fastener from the weighing chamber using tweezers.

9

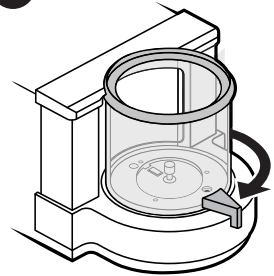

Close the weighing chamber.

10

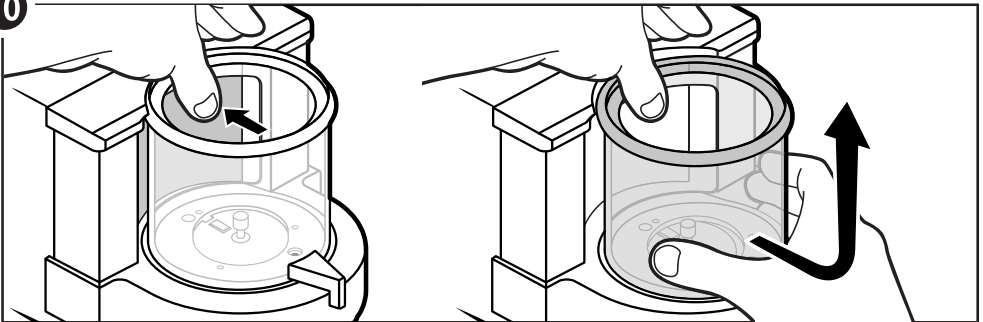

Press the weighing chamber clamp. While pressing the clamp, grab the chamber, move it towards you and up.



After cleaning the weighing chamber elements, they must be assembled in the reverse order.



[www.radwag.com](http://www.radwag.com)